

Chapter 5

Modification Check Values

- ❑ Cryptographic hash functions
- ❑ MDC, MAC
- ❑ MD5, SHA-1
- ❑ H-MAC, CBC-MAC

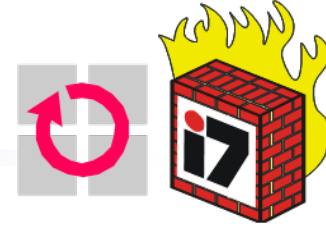

- ❑ It is common practice in data communications to compute some kind of *error detection code* over messages, that enables the receiver to check if a message was ***accidentally altered*** during transmission
 - ❑ Examples: Parity, Bit-Interleaved Parity, Cyclic Redundancy Check (CRC)
- ❑ This leads to the wish of having a similar value that allows to check, if a message has been ***intentionally modified*** during transmission
 - ❑ If somebody wants to intentionally modify a message which is protected with a CRC value he can re-compute the CRC value after modification or modify the message in a way that it leads to the same CRC value
 - ❑ Therefore, a *modification check value* will have to fulfill additional properties that will make it impossible for attackers to forge it
- ❑ Two main categories of modification check values:
 - ❑ ***Modification Detection Code (MDC)***
 - ❑ ***Message Authentication Code (MAC)***

Cryptographic Hash Functions

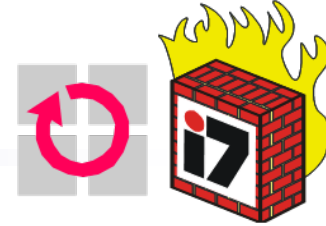

□ Definition: *hash function*

- A *hash function* is a function h which has the following two properties:
 - *Compression*: h maps an input x of arbitrary finite bit length, to an output $h(x)$ of fixed bit length n
 - *Ease of computation*: Given h and x it is *easy* to compute $h(x)$

□ Definition: *cryptographic hash function*

- A *cryptographic hash function* h needs to satisfy the following properties:
 - *Pre-image resistance*: for essentially all pre-specified outputs y , it is computationally infeasible to find an x such that $h(x) = y$
 - *2nd pre-image resistance*: given x it is computationally infeasible to find any second input x' with $x \neq x'$ such that $h(x) = h(x')$
 - *Collision resistance*: it is computationally infeasible to find any pair (x, x') with $x \neq x'$ such that $h(x) = h(x')$
- *Cryptographic hash functions* are used to compute *modification detection codes (MDC)*

Message Authentication Codes (MAC)

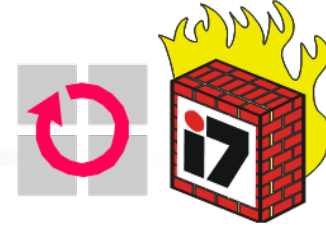

- Definition: *message authentication code*
 - A *message authentication code algorithm* is a family of functions h_k parameterized by a secret key k with the following properties:
 - *Compression*: h_k maps an input x of arbitrary finite bitlength to an output $h_k(x)$ of fixed bitlength, called the MAC
 - *Ease of computation*: given k , x and a known function family h_k the value $h_k(x)$ is easy to compute
 - *Computation-resistance*: for every fixed, allowed, but unknown value of k , given zero or more text-MAC pairs $(x_i, h_k(x_i))$ it is computationally infeasible to compute a text-MAC pair $(x, h_k(x))$ for any new input $x \neq x_i$
 - Please note that *computation-resistance* implies the property of *key non-recovery*, that is k can not be recovered from pairs $(x_i, h_k(x_i))$, but computation resistance can not be deduced from key non-recovery, as the key k need not always to be recovered to forge new MACs

A Simple Attack Against an Insecure MAC

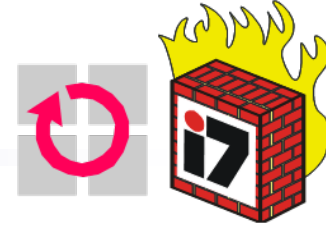

- ❑ For illustrative purposes, consider the following MAC definition:
 - ❑ Input: message $m = (x_1, x_2, \dots, x_n)$ with x_i being 64-bit values, and key k
 - ❑ Compute $\Delta(m) := x_1 \oplus x_2 \oplus \dots \oplus x_n$ with \oplus denoting bitwise exclusive-or
 - ❑ Output: MAC $C_k(m) := E_k(\Delta(m))$ with $E_k(x)$ denoting DES encryption
 - ❑ The key length is 56 bit and the MAC length is 64 bit, so we would expect an effort of about 2^{55} operations to obtain the key k and break the MAC (= being able to forge messages).

- ❑ Unfortunately the MAC definition is insecure:
 - ❑ Assume an attacker Eve who wants to forge messages exchanged between Alice and Bob obtains a message $(m, C_k(m))$ which has been “protected” by Alice using the secret key k shared with Bob
 - ❑ Eve can construct a message m' that yields the same MAC:
 - Let y_1, y_2, \dots, y_{n-1} be arbitrary 64-bit values
 - Define $y_n := y_1 \oplus y_2 \oplus \dots \oplus y_{n-1} \oplus \Delta(m)$, and $m' := (y_1, y_2, \dots, y_n)$
 - When Bob receives $(m', C_k(m))$ from Eve pretending to be Alice he will accept it as being originated by Alice as $C_k(m)$ is a valid MAC for m'

Applications to Cryptographic Hash Functions and MACs



- ❑ Principal application which led original design: **message integrity**
 - ❑ An MDC represents a *digital fingerprint*, which can be signed with a private key, e.g. using the RSA or ElGamal algorithm, and it is not possible to construct two messages with the same fingerprint so that a given signed fingerprint can not be re-used by an attacker
 - ❑ A MAC over a message m directly certifies that the sender of the message possesses the secret key k and the message could not have been modified without knowledge of that key

- ❑ Other applications, which require some caution:
 - ❑ Confirmation of knowledge
 - ❑ Key derivation
 - ❑ Pseudo-random number generation

Attacks Based on the Birthday Phenomenon

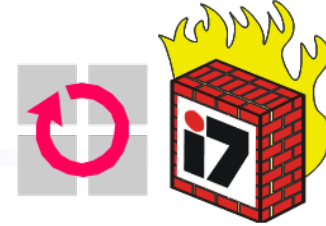

- ❑ The Birthday Phenomenon:
 - ❑ How many people need to be in a room such that the possibility that there are at least two people with the same birthday is greater than 0.5?
 - ❑ For simplicity, we don't care about February, 29, and assume that each birthday is equally likely
- ❑ Define $P(n, k) := \Pr[\text{at least one duplicate in } k \text{ items, with each item able to take one of } n \text{ equally likely values between } 1 \text{ and } n]$
- ❑ Define $Q(n, k) := \Pr[\text{no duplicate in } k \text{ items, each between } 1 \text{ and } n]$
 - ❑ We are able to choose the first item from n possible values, the second item from $n - 1$ possible values, etc.
 - ❑ Hence, the number of different ways to choose k items out of n values with no duplicates is: $N = n \times (n - 1) \times \dots \times (n - k + 1) = n! / (n - k)!$
 - ❑ The number of different ways to choose k items out of n values, with or without duplicates is: n^k
 - ❑ So, $Q(n, k) = N / n^k = n! / ((n - k)! \times n^k)$

Attacks Based on the Birthday Phenomenon

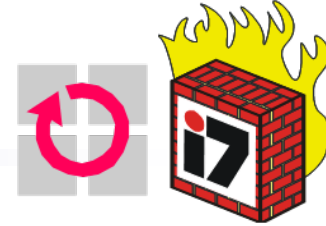

□ We have:
$$P(n, k) = 1 - Q(n, k) = 1 - \frac{n!}{(n-k)! \times n^k}$$
$$= 1 - \frac{n \times (n-1) \times \dots \times (n-k+1)}{n^k}$$

$$= 1 - \left[\frac{n-1}{n} \times \frac{n-2}{n} \times \dots \times \frac{n-k+1}{n} \right]$$
$$= 1 - \left[\left(1 - \frac{1}{n}\right) \times \left(1 - \frac{2}{n}\right) \times \dots \times \left(1 - \frac{k-1}{n}\right) \right]$$

□ We will use the following inequality: $(1 - x) \leq e^{-x}$ for all $x \geq 0$

□ So:

$$P(n, k) > 1 - \left[\left(e^{-1/n} \right) \times \left(e^{-2/n} \right) \times \dots \times \left(e^{-(k-1)/n} \right) \right]$$
$$= 1 - e^{-\left[\frac{1}{n} + \frac{2}{n} + \dots + \frac{k-1}{n} \right]}$$
$$= 1 - e^{-\frac{k \times (k-1)}{2n}}$$

□ In the last step, we used the equality: $1 + 2 + \dots + (k - 1) = (k^2 - k) / 2$

□ Exercise: proof the above equality by induction

Attacks Based on the Birthday Phenomenon

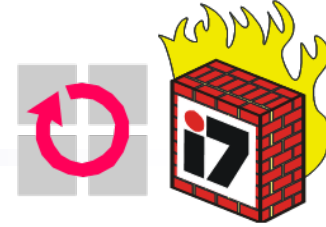

- Let's go back to our original question: how many people k have to be in one room such that there are at least two people with the same birthday (out of $n = 365$ possible) with probability $\geq 0,5$?

- So, we want to solve:

$$\begin{aligned} \frac{1}{2} &= 1 - e^{-k \times (k-1) / 2n} \\ \Leftrightarrow 2 &= e^{k \times (k-1) / 2n} \\ \Leftrightarrow \ln(2) &= \frac{k \times (k-1)}{2n} \end{aligned}$$

- For large k we can approximate $k \times (k - 1)$ by k^2 , and we get:

$$k = \sqrt{2 \ln(2)n} \approx 1.18\sqrt{n}$$

- For $n = 365$, we get $k = 22.54$ which is quite close to the correct answer 23

Attacks Based on the Birthday Phenomenon

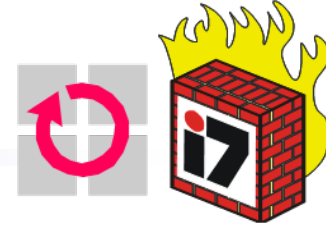

- ❑ What does this have to do with MDCs?
- ❑ We have shown, that if there are n possible different values, the number k of values one needs to randomly choose in order to obtain at least one pair of identical values, is in the order of \sqrt{n}
- ❑ Now, consider the following attack [Yuv79a]:
 - ❑ Eve wants Alice to sign a message $m1$, Alice normally never would sign. Eve knows that Alice uses the function $MDC1(m)$ to compute an MDC of m which has length r bit before she signs this MDC with her private key yielding her digital signature.
 - ❑ First, Eve produces her message $m1$. If she would now compute $MDC1(m1)$ and then try to find a second harmless message $m2$ which leads to the same MDC her search effort in the average case would be on the order of $2^{(r-1)}$.
 - ❑ Instead she takes any harmless message $m2$ and starts producing variations $m1'$ and $m2'$ of the two messages, e.g. by adding <space> <backspace> combinations or varying with semantically identical words.

Attacks Based on the Birthday Phenomenon

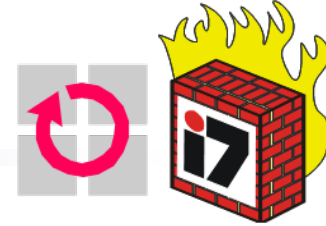

- ❑ As we learned from the birthday phenomenon, she will just have to produce about $\sqrt{2^r} = 2^{r/2}$ variations of each of the two messages such that the probability that she obtains two messages $m1'$ and $m2'$ with the same MDC is at least 0.5
- ❑ As she has to store the messages together with their MDCs in order to find a match, the memory requirement of her attack is on the order of $2^{r/2}$ and its computation time requirement is on the same order
- ❑ After she has found $m1'$ and $m2'$ with $MDC1(m1') = MDC1(m2')$ she asks Alice to sign $m2'$. Eve can then take this signature and claim that Alice signed $m1'$.
- ❑ Attacks following this method are called *birthday attacks*
- ❑ Consider now, that Alice uses RSA with keys of length 2048 bit and a cryptographic hash function which produces MDCs of length 96 bit.
 - ❑ Eves average effort to produce two messages $m1'$ and $m2'$ as described above is on the order of 2^{48} , which is feasible today. Breaking RSA keys of length 2048 bit is far out of reach with today's algorithms and technology.

Overview of Commonly Used MDCs and MACs

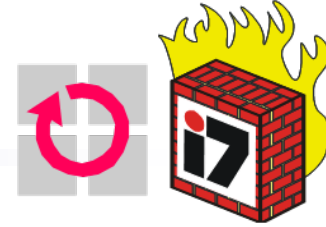

- ❑ Cryptographic Hash Functions for creating MDCs:
 - ❑ Message Digest 5 (MD5):
 - Invented by R. Rivest
 - Successor to MD4
 - ❑ Secure Hash Algorithm 1 (SHA-1):
 - Invented by the National Security Agency (NSA)
 - The design was inspired by MD4

- ❑ Message Authentication Codes:
 - ❑ DES-CBC-MAC:
 - Uses the Data Encryption Standard in Cipher Block Chaining mode
 - In general, the CBC-MAC construction can be used with any block cipher
 - ❑ MACs constructed from MDCs:
 - This very common approach raises some cryptographic concern as it makes some implicit but unverified assumptions about the properties of the MDC

Common Structure of Cryptographic Hash Functions

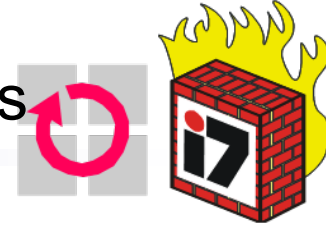

- Like most of today's block ciphers follow the general structure of a Feistel network, most cryptographic hash functions in use today follow a common structure:

- Let y be an arbitrary message. Usually, the length of the message is appended to the message and it is padded to a multiple of some block size b . Let $(y_0, y_1, \dots, y_{L-1})$ denote the resulting message consisting of L blocks of size b
- The general structure is as depicted below:

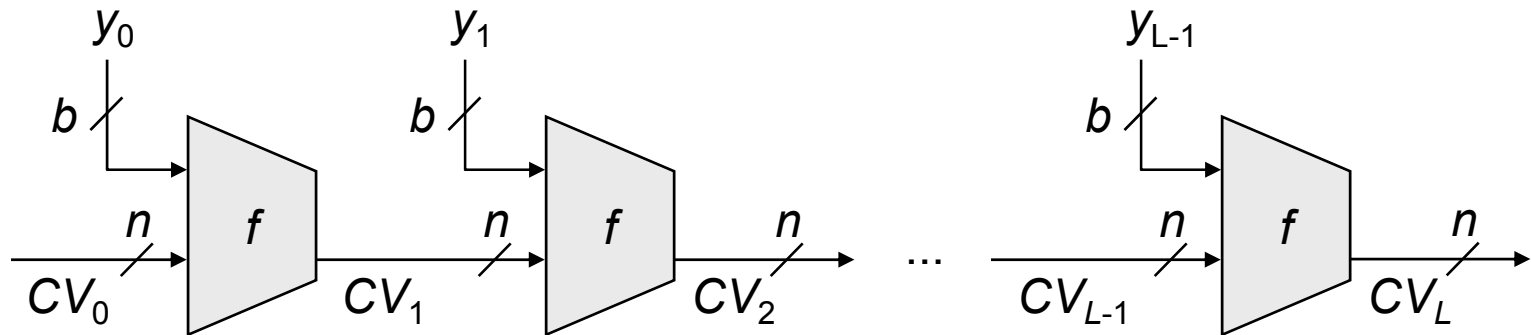

- CV is a *chaining value*, with $CV_0 := IV$ and $MDC(y) := CV_L$
- f is a specific compression function which compresses $(n + b)$ bit to n bit

Common Structure of Cryptographic Hash Functions

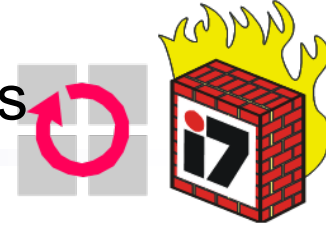

- ❑ The hash function H can be summarized as follows:
 - ❑ CV_0 = IV = initial n -bit value
 - ❑ CV_i = $f(CV_{i-1}, y_{i-1})$ $1 \leq i \leq L$
 - ❑ $H(y)$ = CV_L
- ❑ It has been shown [Mer89a] that if the compression function f is collision resistant, then the resulting iterated hash function H is also collision resistant.
- ❑ Cryptanalysis of cryptographic hash functions thus concentrates on the internal structure of the function f and finding efficient techniques to produce collisions for a single execution of f
- ❑ Primarily motivated by birthday attacks, a common minimum suggestion for n , the bit length of the hash value, is 160 bit, as this implies an effort of order 2^{80} to attack which is considered infeasible today

The Message Digest 5

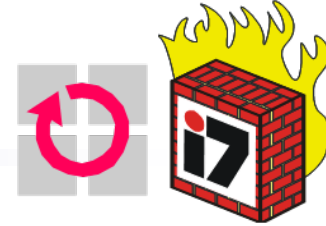

- ❑ MD5 follows the common structure outlined before [Riv92a]:
 - ❑ The message y is padded by a “1” followed by 0 to 511 “0” bits such that the length of the resulting message is congruent 448 modulo 512
 - ❑ The length of the original message is added as a 64-bit value resulting in a message that has length which is an integer multiple of 512 bit
 - ❑ This new message is divided into blocks of length $b = 512$ bit
 - ❑ The length of the chaining value is $n = 128$ bit
 - The chaining value is “structured” as four 32-bit registers A, B, C, D
 - Initialization: $A := 0x\ 01\ 23\ 45\ 67$ $B := 0x\ 89\ AB\ CD\ EF$
 $C := 0x\ FE\ DC\ BA\ 98$ $D := 0x\ 76\ 54\ 32\ 10$
 - This initialization vector is in little-endian format
 - ❑ Each block of the message y_i is processed with the chaining value CV_i with the function f which is internally realized by 4 rounds of 16 steps each
 - Each round uses a similar structure and makes use of a table T containing 64 constant values of 32-bit each,
 - Each of the four rounds uses a specific logical function g

The Message Digest 5

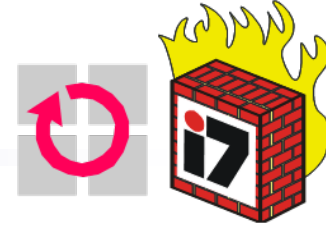

- ❑ The MD5-MDC over a message is the content of the chaining value CV after processing the final message block
- ❑ Security of MD5:
 - ❑ Every bit of the 128-bit hash code is a function of every input bit
 - ❑ Between 1992 and 1996 significant progress in cryptanalyzing MD5 has been published:
 - In 1996 H. Dobbertin published an attack that allows to generate a collision for the function f (realized by the 64 steps described above).
 - While this attack has not yet been extended to a full collision for MD5 with its initialization vector, it raises nevertheless serious concern.
 - ❑ In reaction to this RSA Laboratories publish in 1996 [Rob96a]:
 - *“Existing signatures formed using MD5 are not at risk and while MD5 is still suitable for a variety of applications (namely those which rely on the one-way property of MD5 and on the random appearance of the output) as a precaution it should not be used for future applications that require the hash function to be collision-resistant.”*

The Secure Hash Algorithm SHA-1

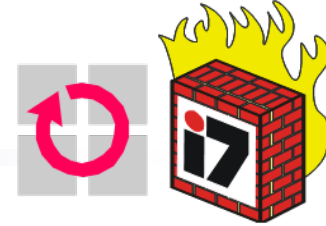

- ❑ Also SHA-1 follows the common structure as described above:
 - ❑ SHA-1 works on 512-bit blocks and produces a 160-bit hash value
 - ❑ As its design was also inspired by the MD4 algorithm, its initialization is basically the same like that of MD5:
 - The data is padded, a length field is added and the resulting message is processed as blocks of length 512 bit
 - The chaining value is structured as five 32-bit registers A, B, C, D, E
 - Initialization:

A = 0x 67 45 23 01	B = 0x EF CD AB 89
C = 0x 98 BA DC FE	D = 0x 10 32 54 76
E = 0x C3 D2 E1 F0	
 - The values are stored in big-endian format
 - ❑ Each block y_i of the message is processed together with CV_i in a module realizing the compression function f in four rounds of 20 steps each.
 - The rounds have a similar structure but each round uses a different primitive logical function f_1, f_2, f_3, f_4
 - Each step makes use of a fixed additive constant K_t , which remains unchanged during one round

The Secure Hash Algorithm SHA-1 – One Step

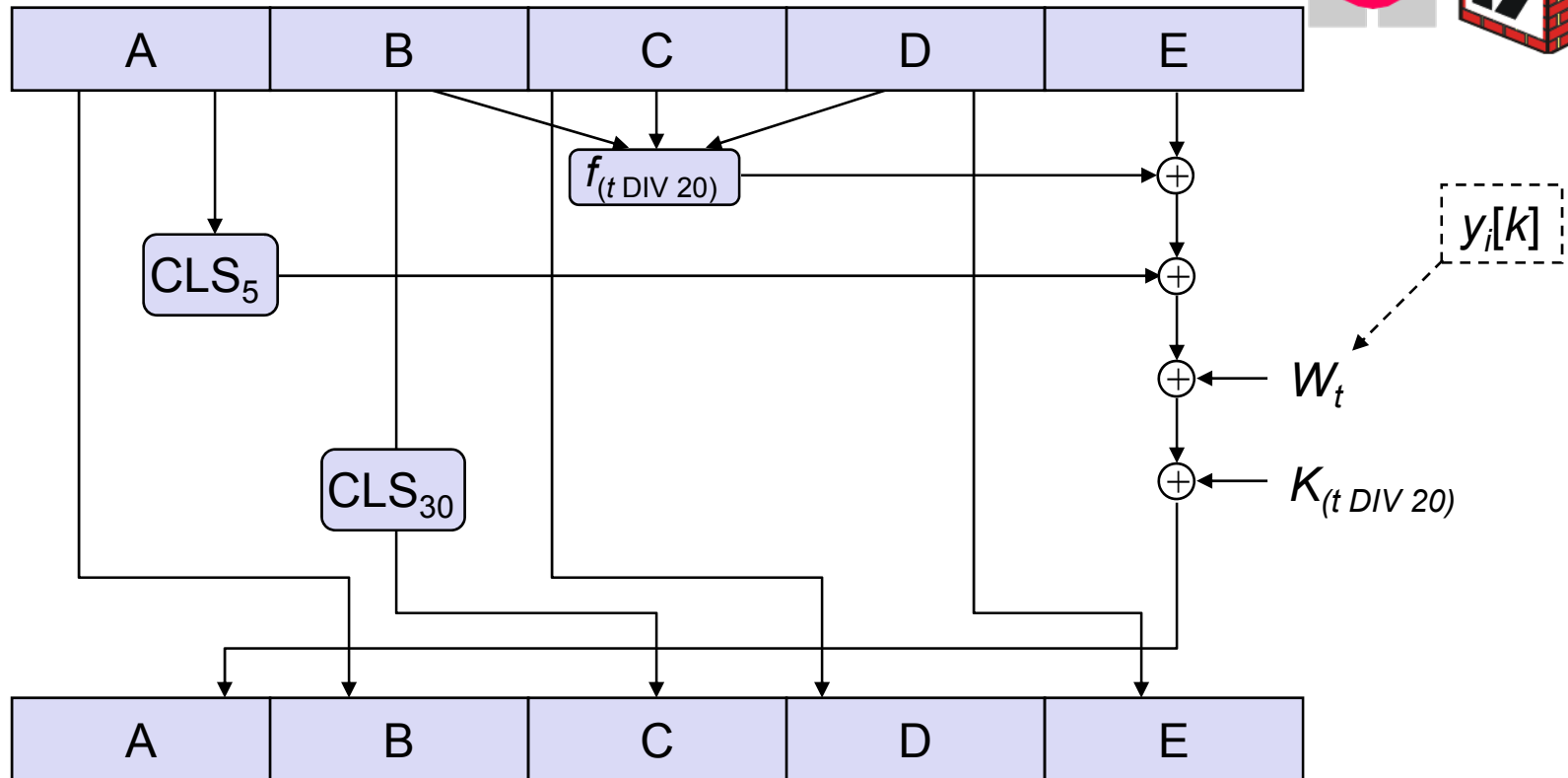
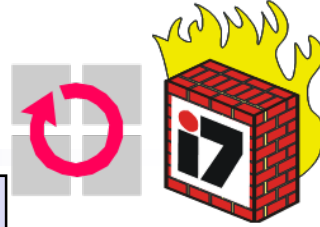

- $t \in \{0, \dots, 15\} \Rightarrow W_t := y_i[t]$
- $t \in \{16, \dots, 79\} \Rightarrow W_t := CLS_1(W_{t-16} \oplus W_{t-14} \oplus W_{t-8} \oplus W_{t-3})$
- After step 79 each register A, B, C, D, E is added modulo 2^{32} with the value of the corresponding register before step 0 to compute CV_{i+1}

The Secure Hash Algorithm SHA-1

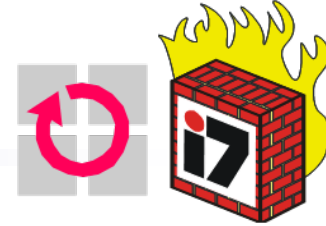

- ❑ The SHA-1-MDC over a message is the content of the chaining value CV after processing the final message block
- ❑ Security of SHA-1:
 - ❑ As SHA-1 produces MDCs of length 160 bit, it offers better security against brute-force and birthday attacks than MD5
 - ❑ Up to now, no cryptanalytic results against the compression function of SHA-1 have been published
 - However, it has to be stated, that the design criteria of SHA-1 are not known, which makes cryptanalysis more difficult
- ❑ Further comparison between SHA-1 and MD5:
 - ❑ Speed: SHA-1 is about 25% slower than MD5 (CV is about 25% bigger)
 - ❑ Simplicity and compactness: both algorithms are simple to describe and implement and do not require large programs or substitution tables
 - ❑ Little-endian vs. big-endian architecture: no advantage of either approach
 - ❑ RSA Laboratories (who invented MD5) recommend SHA-1 or RipeMD-160 for applications that require collision resistance [Rob96a]

Constructing a MAC from a MDC

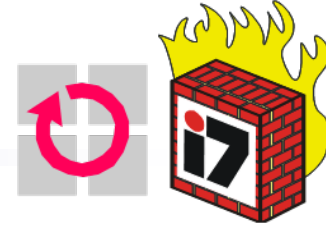

- ❑ Reasons for constructing MACs from MDCs:
 - ❑ Cryptographic hash functions generally execute faster than symmetric block ciphers
 - ❑ There were no export restrictions to cryptographic hash functions
- ❑ Basic idea: “mix” a secret key K with the input and compute an MDC
 - ❑ The assumption that an attacker needs to know K to produce a valid MAC nevertheless raises some cryptographic concern:
 - The construction $H(K, m)$ is not secure (see note 9.64 in [Men97a])
 - The construction $H(m, K)$ is not secure (see note 9.65 in [Men97a])
 - The construction $H(K, p, m, K)$ with p denoting an additional padding field does not offer sufficient security (see note 9.66 in [Men97a])
 - ❑ The most used construction is: **$H(K, p_1, H(K, p_2, m))$**
 - Two different padding patterns p_1 and p_2 are used to fill up the key to one input block of the cryptographic hash function
 - This scheme seems to be secure (see note 9.67 in [Men97a])
 - It has been standardized in RFC 2104 [Kra97a] and is called *HMAC*

Cipher Block Chaining Message Authentication Codes



- A CBC-MAC is computed by encrypting a message in CBC Mode and taking the last ciphertext block or a part of it as the MAC:

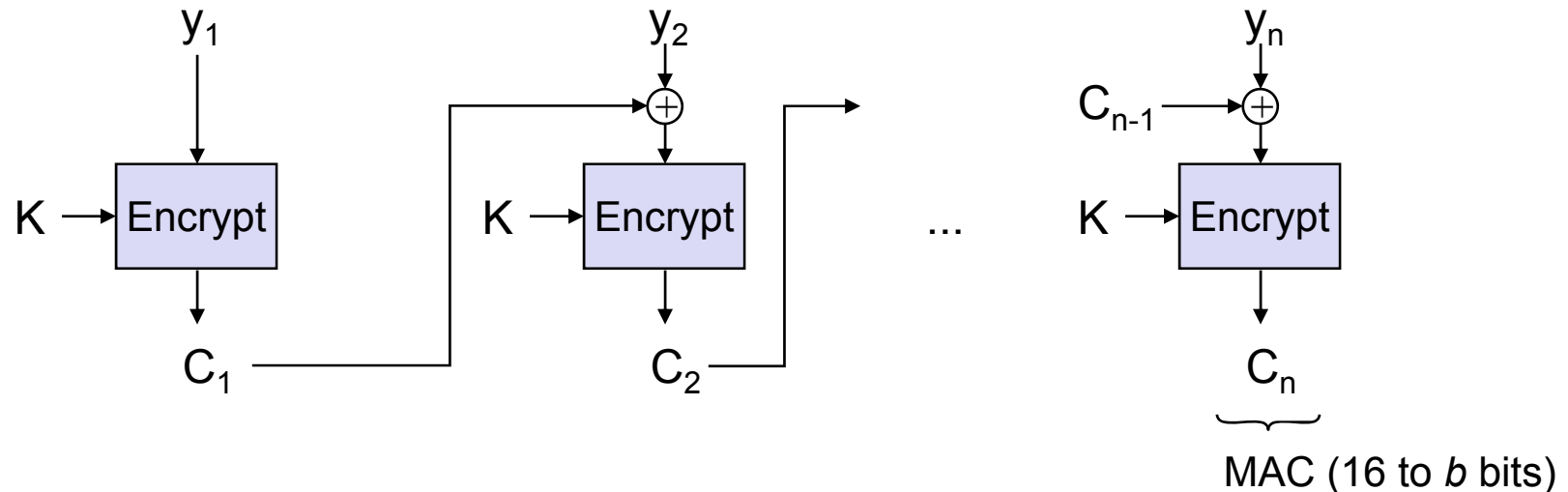

- This MAC needs not to be signed any further, as it has already been produced using a shared secret K
 - However, it is not possible to say who exactly has created a MAC, as everybody (sender, receiver) who knows the secret key K can do so
- This scheme works with any block cipher (DES, IDEA, ...)

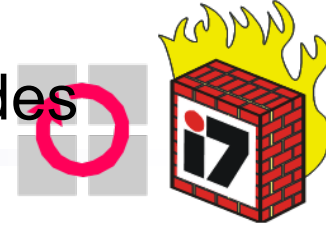

❑ Security of CBC-MAC:

- ❑ As an attacker does not know K , a birthday attack is much more difficult to launch (if not impossible)
- ❑ Attacking a CBC-MAC requires known (message, MAC) pairs
- ❑ This allows for shorter MACs
- ❑ A CBC-MAC can optionally be strengthened by agreeing upon a second key $K' \neq K$ and performing a triple encryption on the *last* block:

$$\text{MAC} = E(K, D(K', E(K, C_{n-1})))$$

- ❑ This doubles the key space while adding only little computing effort
- ❑ There have also been some proposals to create MDCs from symmetric block ciphers with setting the key to a fixed (known) value:
 - ❑ Because of the relatively small block size of 64 bit of most common block ciphers, these schemes offer insufficient security against birthday attacks
 - ❑ As symmetric block ciphers require more computing effort than dedicated cryptographic hash functions, these schemes are relatively slow

Summary (what do I need to know)

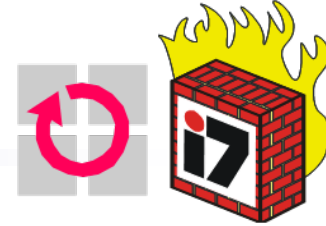

- ❑ Principles of cryptographic hash functions
 - ❑ Modification detection code (MDC)
 - ❑ Message authentication code (MAC)

- ❑ MD5
 - ❑ Operation principles
 - ❑ Security

- ❑ MAC
 - ❑ H-MAC – using a cryptographic hash function
 - ❑ CBC-MAC – using a symmetric block cipher in CBC mode

Additional References

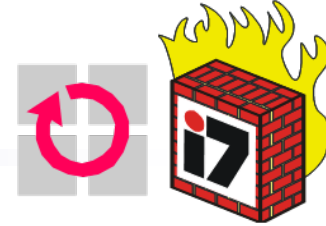

- [Men97a] A. J. Menezes, P. C. Van Oorschot, S. A. Vanstone. *Handbook of Applied Cryptography*. CRC Press Series on Discrete Mathematics and Its Applications. CRC Press, 1997.
- [Kra97a] H. Krawczyk, M. Bellare, R. Canetti. *HMAC: Keyed-Hashing for Message Authentication*. Internet RFC 2104, February 1997.
- [Mer89a] R. Merkle. *One Way Hash Functions and DES*. Proceedings of Crypto '89, Springer, 1989.
- [Riv92a] R. L. Rivest. *The MD5 Message Digest Algorithm*. Internet RFC 1321, April 1992.
- [Rob96a] M. Robshaw. *On Recent Results for MD2, MD4 and MD5*. RSA Laboratories' Bulletin, No. 4, November 1996.
- [Yuv79a] G. Yuval. *How to Swindle Rabin*. Cryptologia, July 1979.